

 SUPAIR

English



# ALTIRANDO LITE

User's manual

SUPAIR-VLD  
PARC ALTAÏS  
34 RUE ADRASTÉE  
74650 ANNECY CHAVANOD  
FRANCE

45°54.024'N / 06°04.725' E

RCS 387956790

Revision index : 11/04/2019



Thank you for choosing the ALTIRANDO LITE harness. We are glad to be able to share our common paragliding passion with you.

SUP'AIR has been designing, producing and selling free flying equipment since 1984. By choosing a SUP'AIR product you benefit from almost thirty years of expertise, innovation and listening. Our mission statement: research and develop to constantly enhance.

We hope you will find this user's manual comprehensive, explicit and hopefully enjoyable as well. We advise you to read it carefully.

You will find the latest updated information about this product on our website : **www.supair.com**. If you have further inquiries, feel free to ask one of our retailers for answers. And naturally, the entire SUP'AIR team is at your disposal at : **info@supair.com**

We wish you many safe enjoyable flying hours and happy landings.

Team SUP'AIR

# LIST OF CONTENTS

<b>Introduction</b>	<b>4</b>	<b>Inflight behavior</b>	<b>23</b>
<b>Technical specifications</b>	<b>5</b>	<b>Flight phases</b>	<b>24</b>
<b>Size choice</b>	<b>6</b>	Pre-Flight check	24
<b>Components list</b>	<b>7</b>	Takeoff	24
<b>Equipment overview</b>	<b>8</b>	In flight	25
<b>Accessories assembly</b>	<b>9</b>	Speed-bar use	25
Seat-plate	9	Landing	25
Carabiners	9	<b>Using the reserve parachute</b>	<b>26</b>
Speed-bar system	10	<b>Towing</b>	<b>26</b>
Foot-rest	11	<b>Mandatory controls</b>	<b>26</b>
<b>Installing the reserve parachute</b>	<b>12</b>	<b>In case of an incident</b>	<b>27</b>
Reserve parachute characteristics	12	<b>Maintenance</b>	<b>28</b>
POD reserve parachute handle connection	12	Harness cleaning and maintenance	28
Parachute risers – harness connection	13	Storage and transport	28
Place the risers inside the sleeve	15	Product longevity	28
Parachute risers – reserve parachute connection	16	Repairs / spare parts	29
Installing the reserve parachute in its container	17	Materials	29
Locking the reserve parachute handle	18	Recycling	29
<b>Gear packing and tips</b>	<b>19</b>	<b>Warranty</b>	<b>30</b>
<b>Adjustments</b>	<b>20</b>	<b>Disclaimer</b>	<b>30</b>
The various adjustments	20	<b>Pilot's gear</b>	<b>30</b>
Switching to backpack mode	21	<b>Service Book</b>	<b>31</b>
<b>Wing/harness connection</b>	<b>22</b>		



Welcome to the paragliding world according to SUPAIR; a world of shared passion.

The ALTIRANDO LITE targets enthused pilots of all levels.  
It was designed with schooling and fun in mind to provide full comfort and a worry free learning curve.

harness was certified EN 1651 : 1999 and LTF 91/09  
Indicating that it meets European and German safety requirements.

After reading this manual, check your harness during a hang-test to fully adjust it before your first flight.

N.B : Three important icons will help you when reading this manual



Advice



Caution !



Danger !!



# TECHNICAL SPECIFICATIONS

Harness size		S	M	L	XL
	Pilot size (cm)	155-175	170-185	180-195	190-205
	Pilot weight (mini - maxi) (kg)	60 - 80	65 - 85	70 - 100	90 - 120
	Harness weight (+carabiners+speedbar)(kg)	-	2800	3000	-
	Designed for	Hike & Fly Progression			
A	Backrest height (cm)	-	65	71	75
B	Backrest tilt adjustments (cm)	-	34	38	40
C	Seat depth (cm)	-	46	48	50
D	Seat width (cm)	-	39	41	43
E	Hooking point height (cm)	-	45	45	
F	Length between the hooking points (cm)	-	37-45	38-48	
	Impact damping system: Airbag	Yes			
	Impact damping system: Bumpair	Non			
	Certification	EN 1651 : 1999 and LTF 91/09			
	Tandem (Pilot or Passenger)	Passenger only			
	Acrobatic flying	No			
	Towing	Yes			
	Releasable carabiners	No			
	Reserve parachute pocket volume	min : 3000 cm <sup>3</sup> - max : 7000 cm <sup>3</sup>			

- A** Backrest height
- D** Seat width
- B** Backrest tilt adjustments
- E** Hooking point height
- C** Seat depth
- F** Length between the hooking points

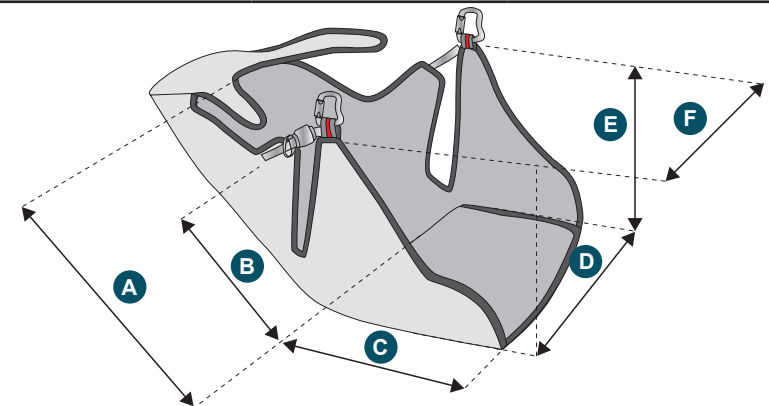

# SIZE CHOICE

Choosing your harness' size is important. You will find here below a height/weight table to help you with your size choice. With its hammock architecture and reclined flying posture, we advise you to try out the harness during a hang-test first at one of.

Complete list of our retailers : [www.supair.com](http://www.supair.com).

Size Weight	1m55	1m60	1m65	1m70	1m75	1m80	1m85	1m90	1m95	2m
50	S	S	S	S						
55	S	S	S	S						
60	S	S								
65	S	S			M	M	M			
70			M	M	M	M	M			
75			M	M	M			L	L	
80			M	M	M			L	L	
85						L	L	L	L	
90						L	L	L		XL
95						L	L	L		XL
100						L	L		XL	XL
105						L	L		XL	XL
110									XL	XL
115									XL	XL

 Preliminary hang-test

# NOMENCLATURE

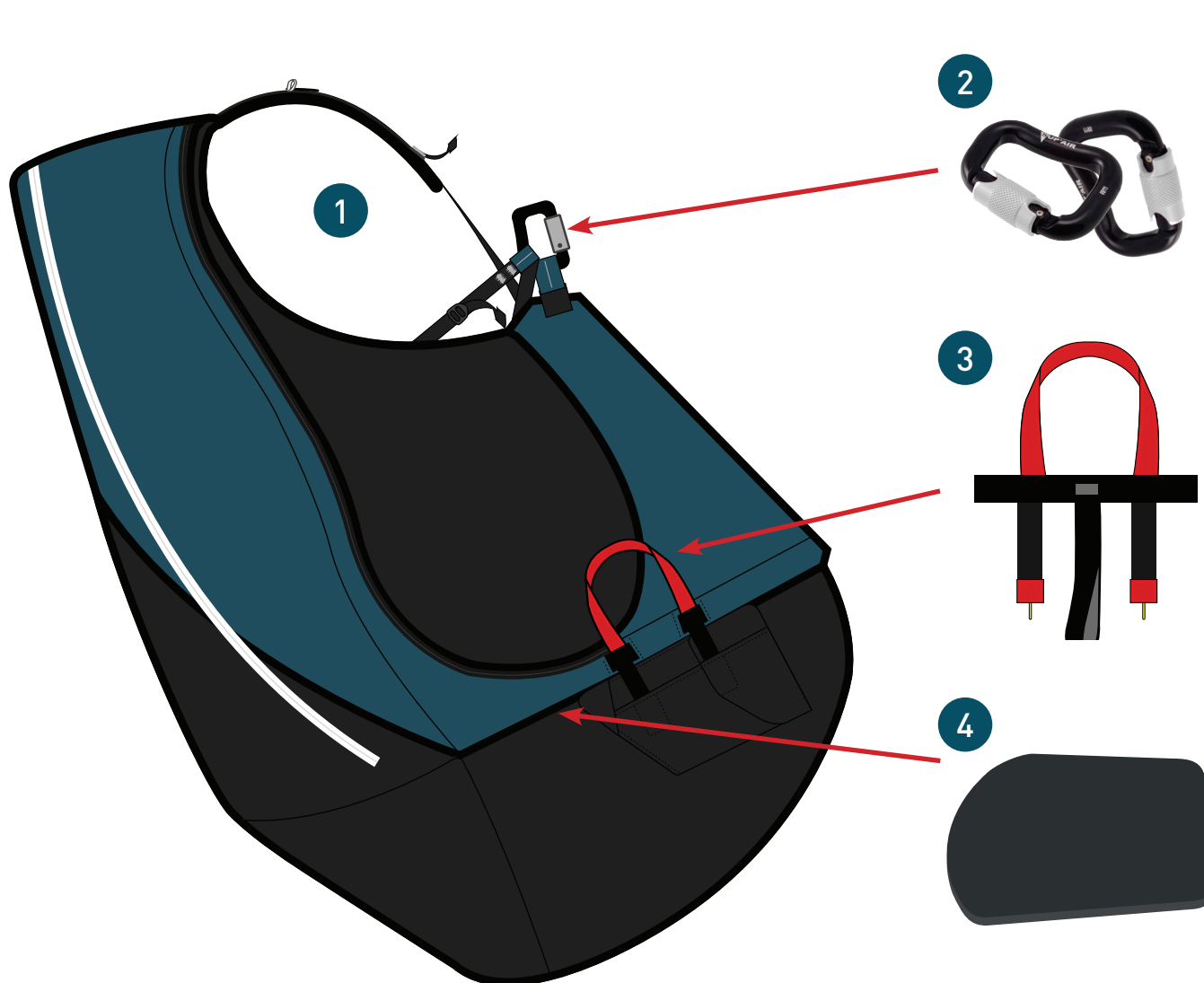

- 1 Harness
- 2 Zicral 30 mm carabiners
- 3 « ATL » reserve parachute handle
- 4 Polypropylene seat plate

## Options

Double stage accelerator/speed-bar  
(ref. : CALEPIEDRETRACT20)

Speed-bar/accelerator 2B light  
(ref: ACCELSOUPLELIGHT)

Adjustable accelerator FreeSpeed  
(ref: ACCELFREESPEE)

Solo DYNEEMA risers  
(ref. : ELESOLODYNEEMA)

Carbon seat plate  
(ref. :seat plate S 33\*34cm: MPPL005)  
(ref. :seat plate M 35\*37cm: MPPL006)  
(ref. :seat plate L: 37\*37cm : MPPL007)  
(ref. :seat plate XL 39\*37cm : MPPL008)

# HARNES OVERVIEW

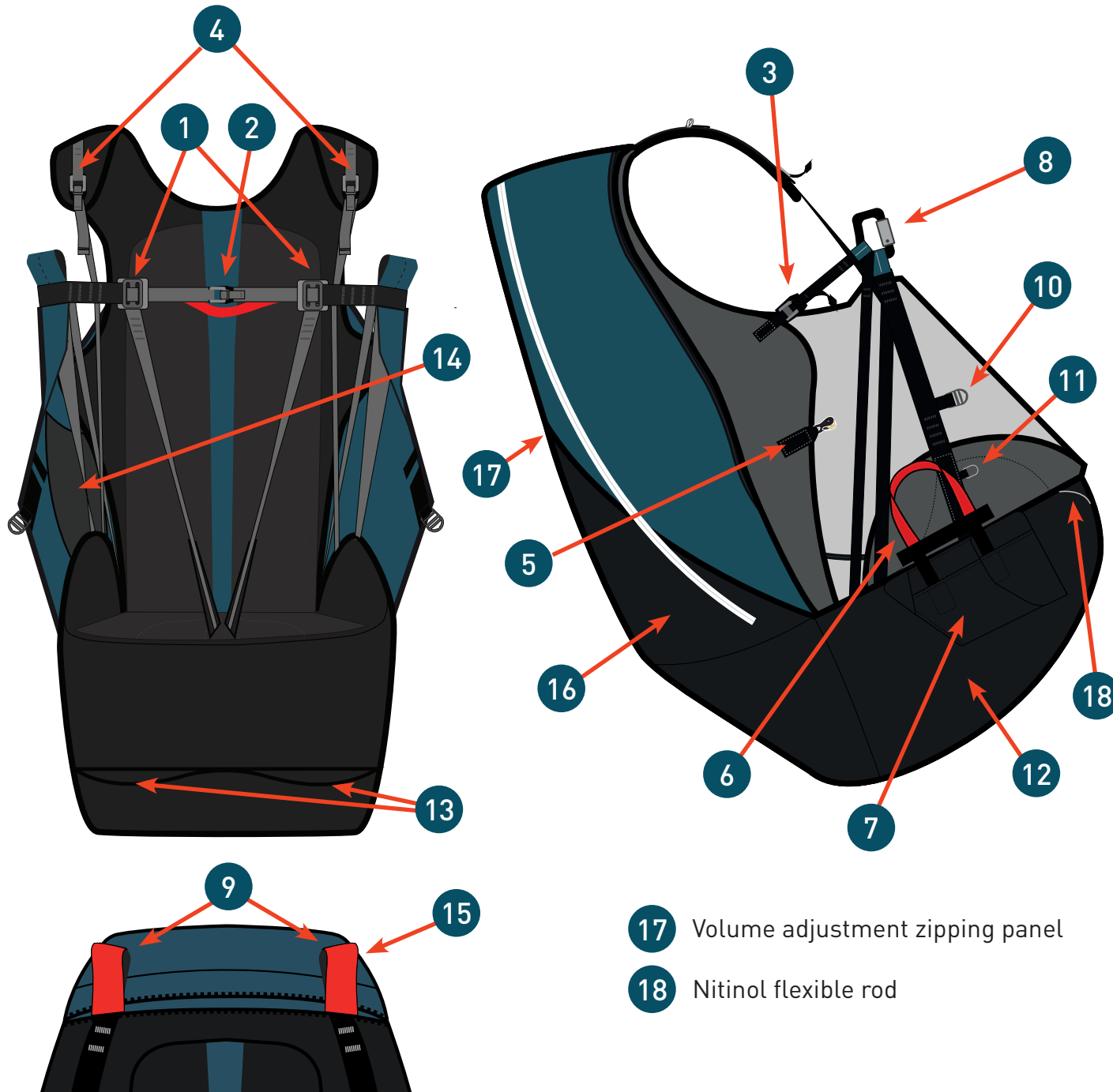

- 1 Chest and leg straps
- 2 Chest strap adjustment
- 3 Backrest tilt adjustment
- 4 Shoulder straps adjustments
- 5 Speed-bar / Accelerator pulleys
- 6 Reserve parachute handle
- 7 Reserve parachute pocket
- 8 Reserve parachute paragliding main hooking points
- 9 Reserve parachute hooking points
- 10 Foot-rest buckle
- 11 "D" ring guide for the Speed-bar/accelerator
- 12 AIRBAG
- 13 AIRBAG air intake
- 14 Radio and small storage pocket
- 15 Hydration tube opening
- 16 Back storage pocket
- 17 Volume adjustment zipping panel
- 18 Nitinol flexible rod



# ACCESSORIES ASSEMBLY

## Carabiners

### Compatible carabiners :

Zicral 30 mm carabiners

Réf. : MAILCOMOUS30

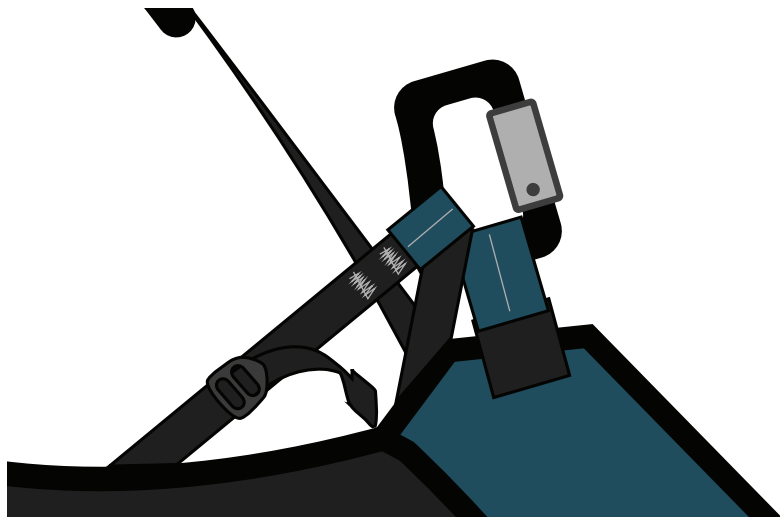
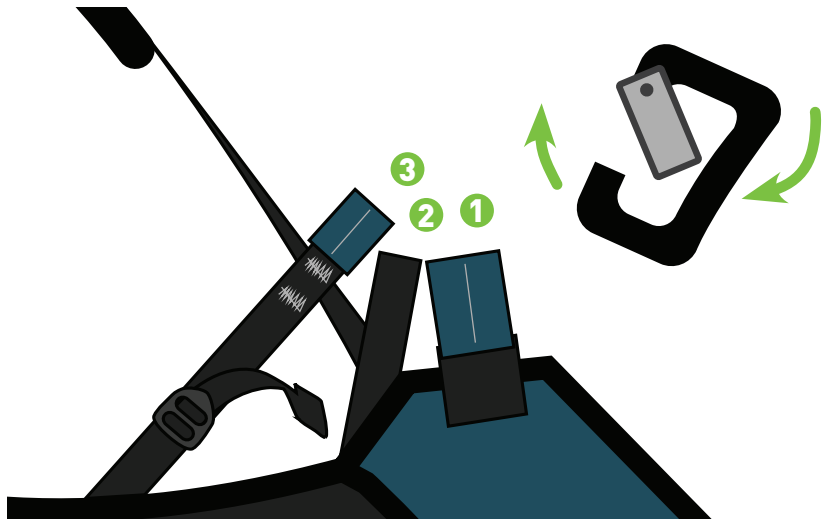

## Seat plate

### Polypropylene seat plate

Size S Ref. : MPPL030

Size M Ref. : MPPL031

Size L Ref. : MPPL032

Size XL Ref. : MPPL033



### Installing the seat plate :

1. Open the velcro located under the rear side of the seat.
2. Slide the seat plate inside its housing and fasten the velcro.

Rear

Front



Flight direction →

## Speed-bar system (option)

### Compatible speed-bar/accelerator :

STANDARD double stage speed-bar/accelerator

(Réf. : ACCELSOUPLE)

Speed-bar/accelerator 2B light

( ref: ACCELSOUPLELIGHT)

Adjustable speed-bar/accelerator FREESPEE

( ref: ACCELFREESPEE)

### Speedbar assembly :

Regarding either side of the harness:

- 1 Push the speed-bar/accelerator cord through the grommet located at the front of the harness.
- 2 Push the speed-bar/accelerator cord through the "D" ring.
- 3 Push the speed-bar/accelerator cord through the pulley located on the lateral side wall.
- 4 Finally, attach a hook to the cord before connecting it to the glider's speed-bar/accelerator.

Simulate the speed-bar/accelerator's functionality by sliding the cord back and forth.



There is one Velcros® to keep the speed-bar/accelerators without elastic cord in place.

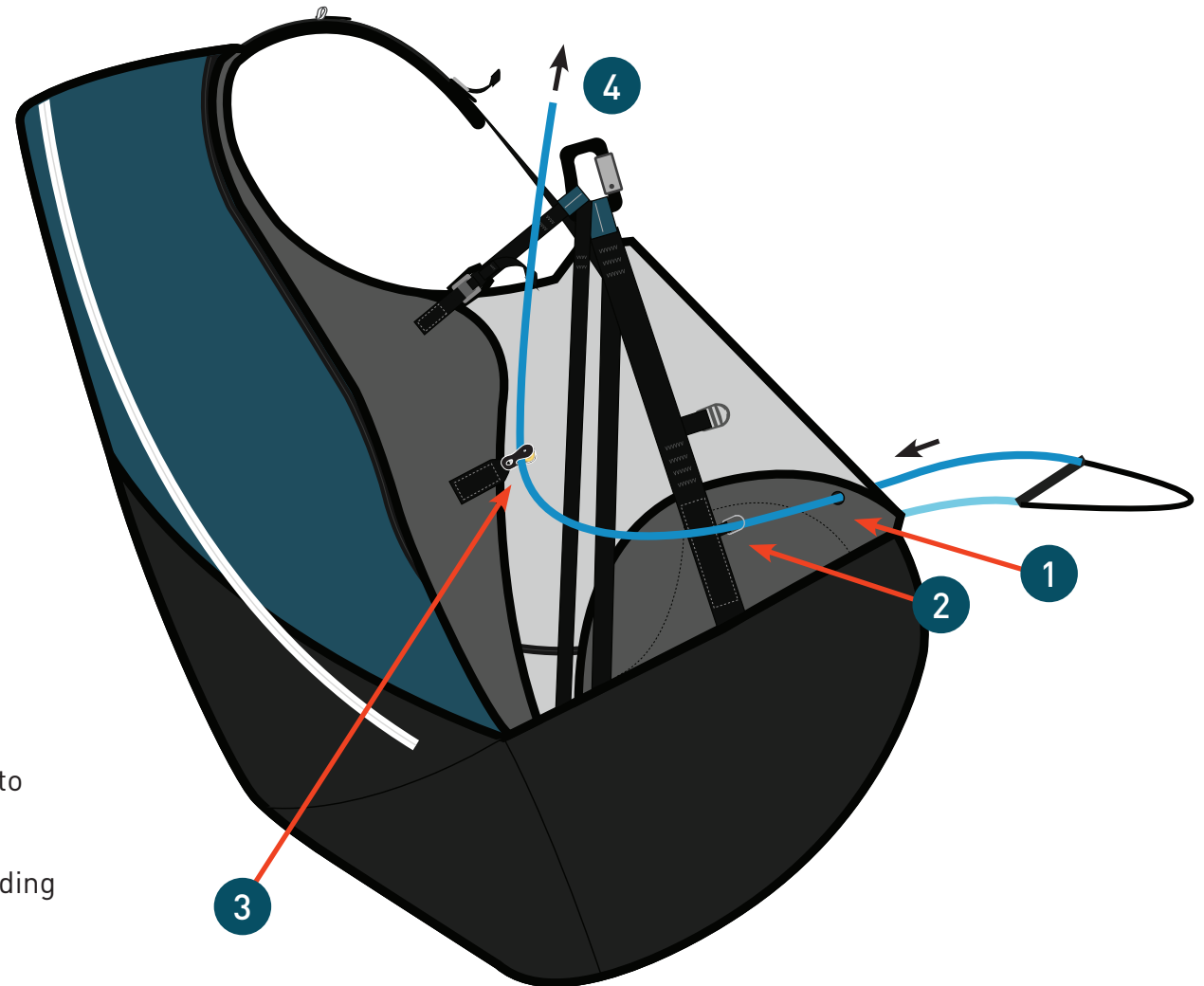

## Foot-rest (option)

- 1 Push the foot-rest strap through buckle located at the front of the harness's side skirt.
- 2 Push the elastic cord through the main hooking point located beneath the self-locking carabiner.
- 3 Adjust the foot-rest length during a hang-test and stow away the straps excess in the elasticated holder.

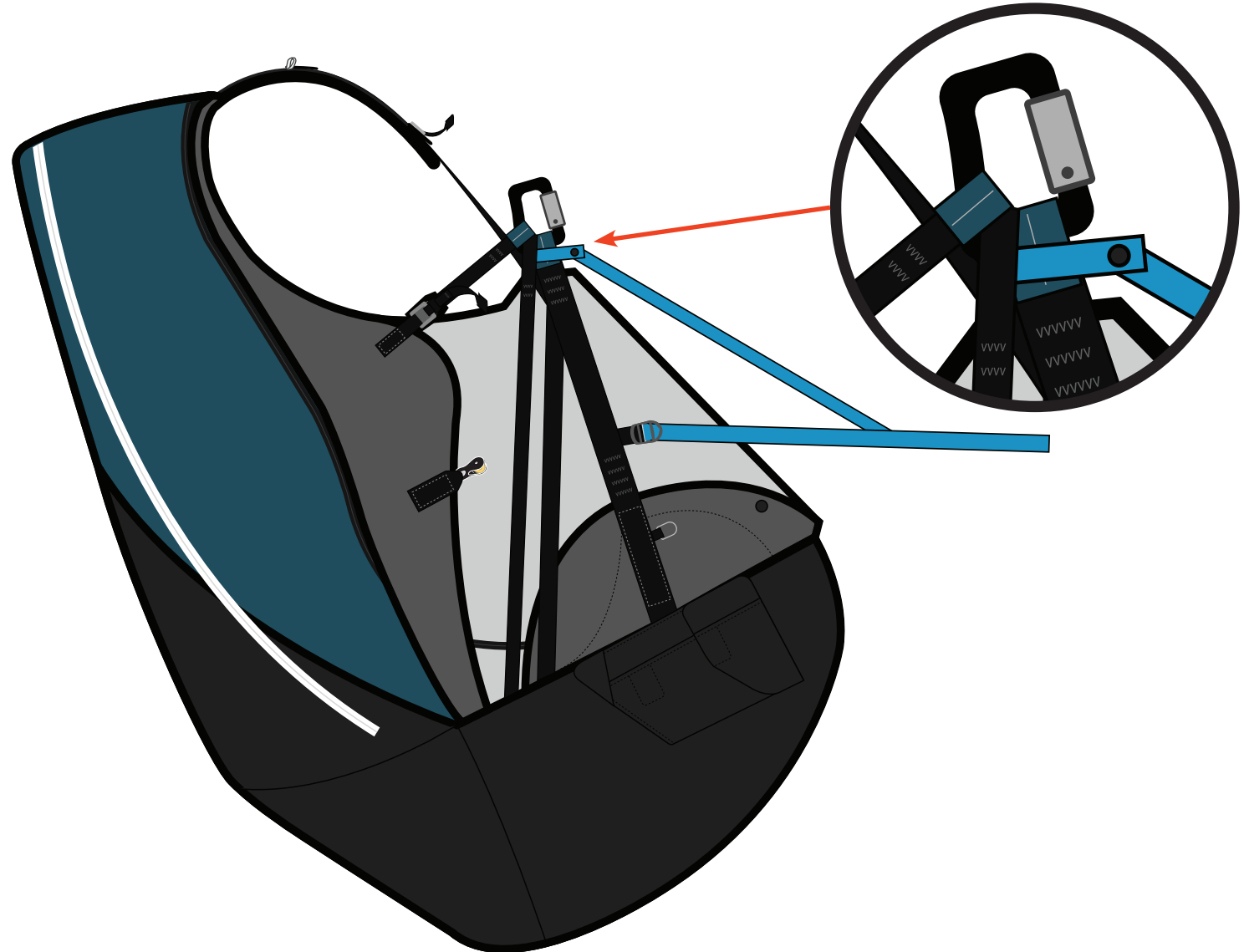
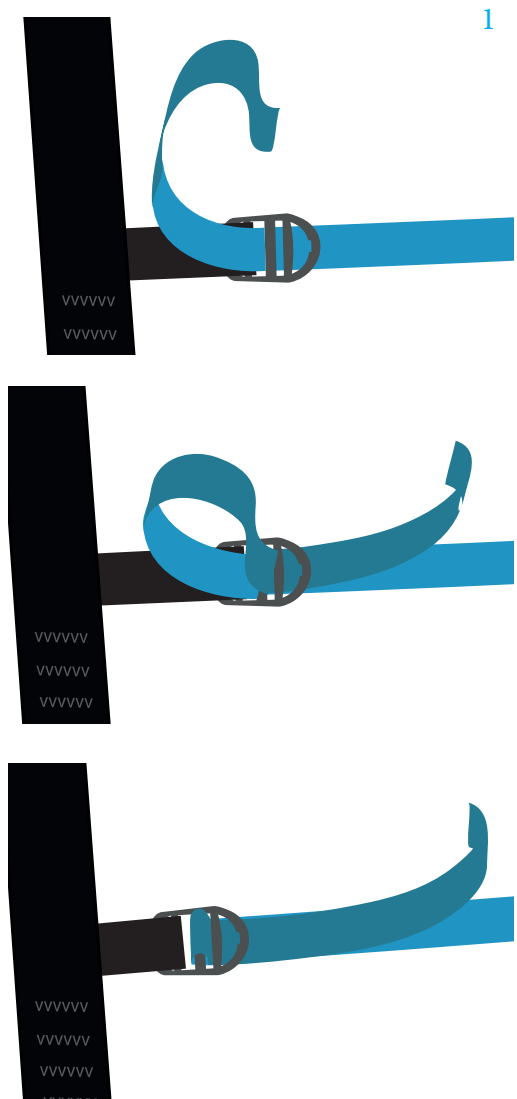

# INSTALLING THE RESERVE PARACHUTE



Thank you for reading the following carefully ! We recommend for the initial rescue parachute assembly and installation to be made by a qualified professional.

Reserve parachute folding and installation inside the harness must conform to the specific guidelines found in this manual.

## Rescue parachute pocket characteristics



- Container closed via cables
- Volume: 3 to 7 liters
- Adapted to the reserve parachutes SUPAIR, START, SHINE and FLUID as well as other rescue solo models.

ALTIRANDO LITE size S and M			
Compatible parachutes	S	M	L
SHINE	✓	✓	✓
START		✓	✓
FLUID	✓	✓	✓

ALTIRANDO LITE size L and XL			
Compatible parachutes	S	M	L
SHINE	✓	✓	✓
START		✓	✓
FLUID	✓	✓	✓

## Connecting the handle to the rescue parachute's deployment bag.

- 1 Fasten the reserve parachute handle bridle to the external pod loop via a Lark's head knot connection.

If you have a large reserve parachute, and feel a slight resistance during the pod extraction hang-test, connect the reserve parachute handle to the side loop instead.

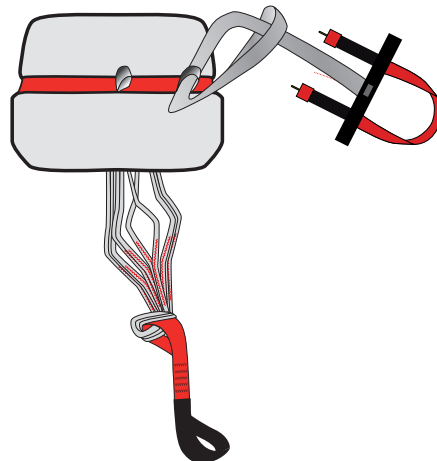

- 2 Tighten the handle/POD connection securely.

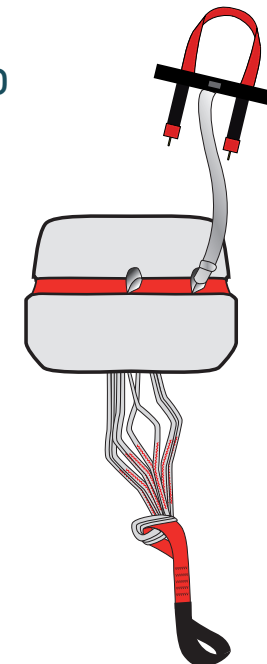

# INSTALLING THE RESERVE PARACHUTE

## Riser/Harness connection :

### >> Access to the reserve parachute connection points.

First, open the riser guiding sleeve all the way from top to bottom to access the reserve parachute connection loops. Once the riser guiding sleeve is fully opened, the zipper tab must be located on the same side of the reserve parachute pocket.



We recommend using "split" risers to guarantee a clean reserve parachute deployment.

### A Fastening the risers to the harness via a Lark's head knot connection.

1 Attach each riser to the shoulder attachment points by making a Lark's knot ( loop to loop connection ). Use the largest bridle loop ends.

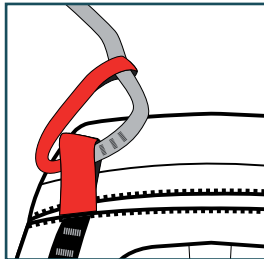

2 Assemble everything correctly. Make sure for the risers not to be longer than one another.

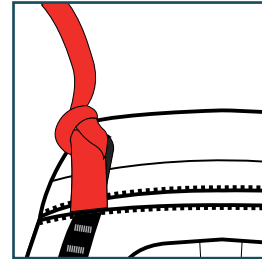

3 Tighten each connection securely.

### B Fastening the risers to the harness with a set of 6mm square Maillons Rapides®

Take two 6mm square Maillons Rapides® and two toric elastic rings.

1 Open the 6mm Maillon Rapide®.

- Push the toric ring through the Maillon Rapide® and twist it.

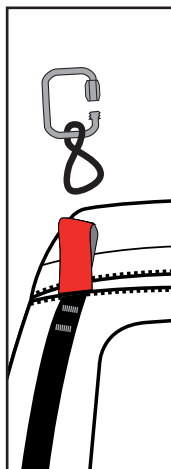

2 Push the bridle connecting point through the toric ring loop.

- Push the Maillon Rapide® through the bridle connection loop.

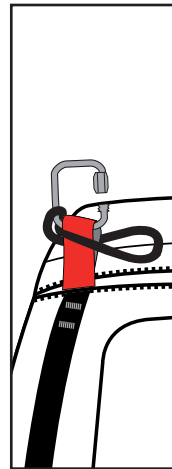

3 Give the toric ring a second twist.

- Push the bridle through the Maillon Rapide®.  
- Make sure the riser stays in place.

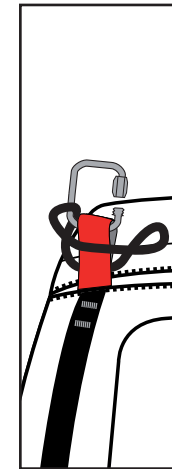

4 Close the Maillon Rapide® by hand, then tighten using a set of pliers and making a 1/4 turn.

- Repeat the procedure with the second bridle connection loop.

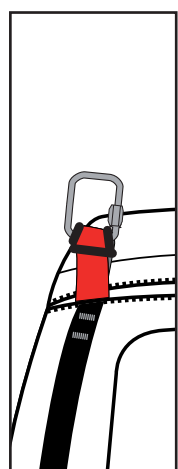



# INSTALLING THE RESERVE PARACHUTE

## Riser/Harness connection :

Fastening the risers to the harness with a set of 6mm square Maillons Rapides®

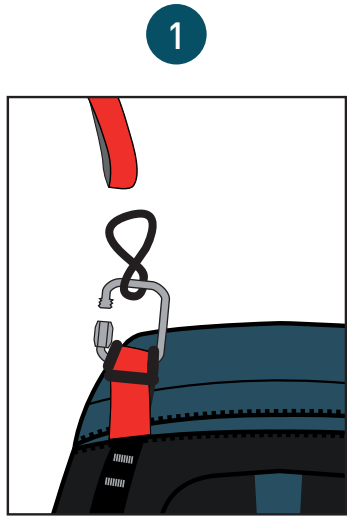

- Open the 6mm Maillon Rapide®.
- Push the toric ring through the Maillon Rapide® and twist it.

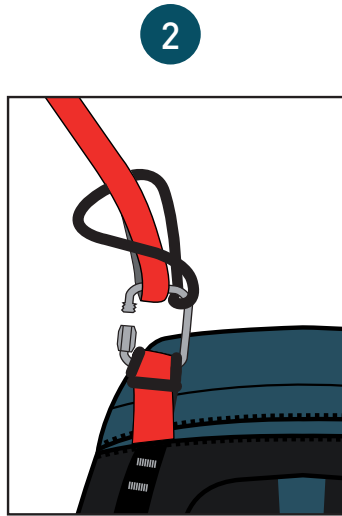

- Push the riser connecting point through the toric ring loop.
- Push the riser in the 6mm Maillon Rapide®.

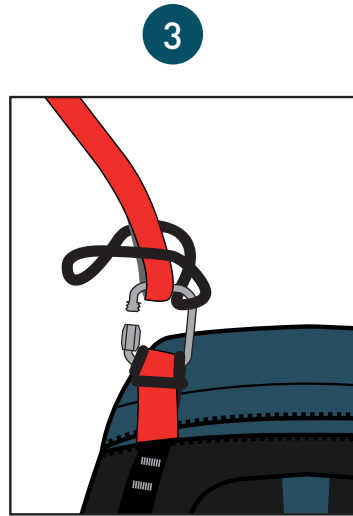

- Give the toric ring a second twist.

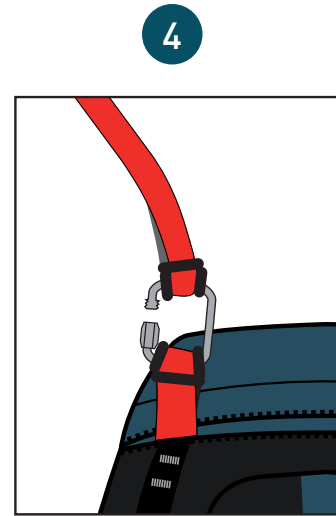

- Push the riser end loop through the Maillon Rapide®.

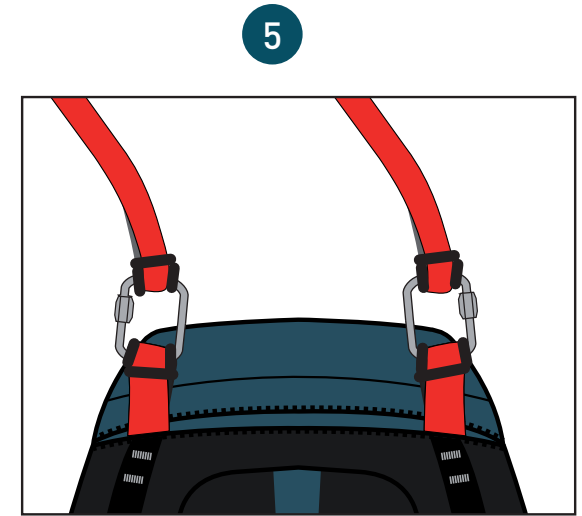

- Check that the risers do not move.
- Close the Maillon Rapide® by hands and tighten with a 1/4 turn using set of pliers.
- Repeat the procedure with the second riser.

# INSTALLING THE RESERVE PARACHUTE

Place the risers inside the sleeve.

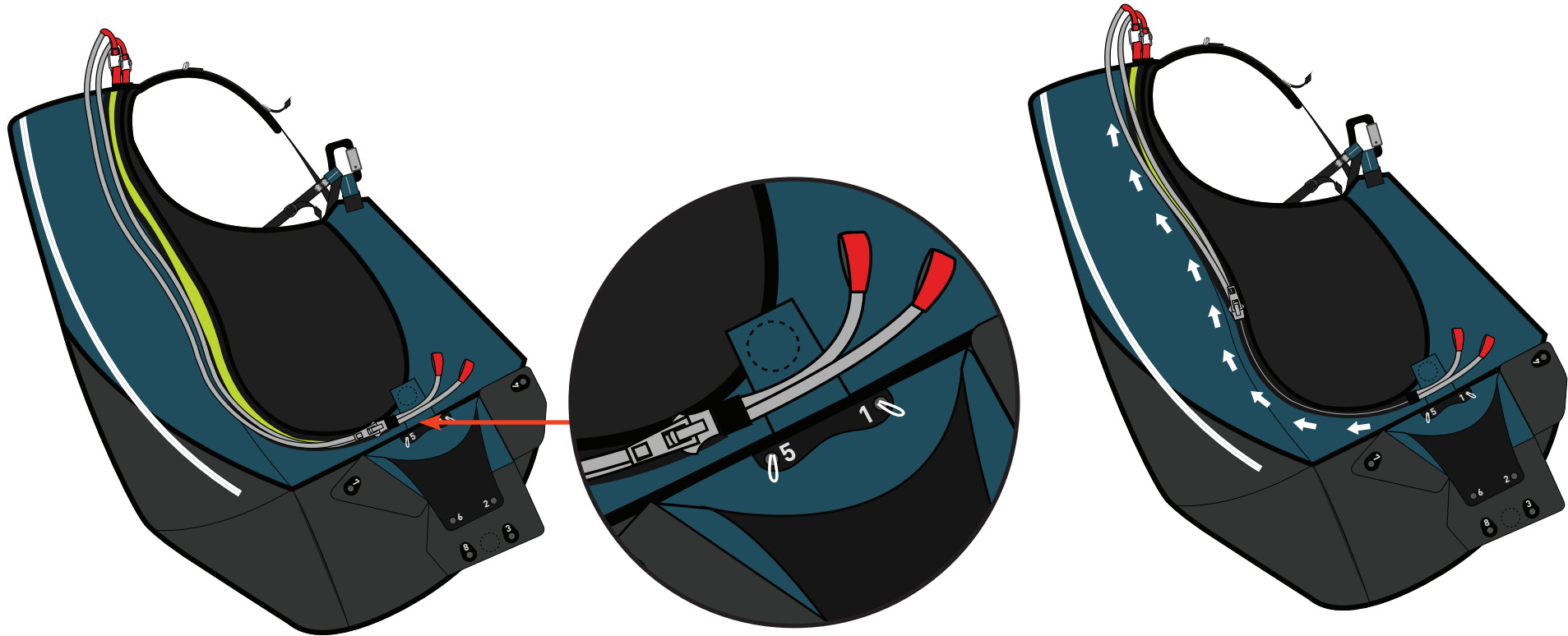

- 1 - Place the risers inside their guiding/protective sleeve connected alongside the harness.
  - Push them through and under the zipper tab.
  - Bring them out through the reserve parachute container.

- 2 - Push the connection points inside the sleeve.
  - Close the Zip to the tab above the left shoulder.

# INSTALLING THE RESERVE PARACHUTE

## Reserve parachute/risers.

One (1) square 7mm Maillon Rapide® will be needed + two (2) flexible toric rings.

1

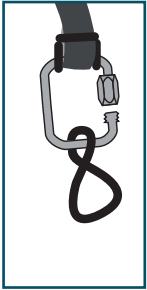

- Open the 7mm square Maillon Rapide®
- Push the maillon through the risers loops
- Push the maillon through the plastic ring
- Twist

2

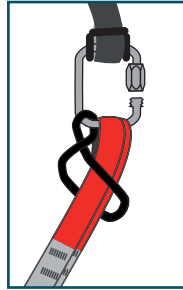

- Push the two riser ends through the toric ring loop.
- Push the maillon through the riser loop

3

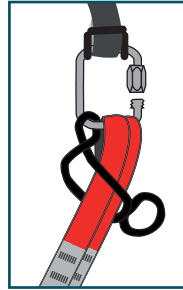

- Give a second twist to the plastic ring.
- Push the buckle through the maillon.

4

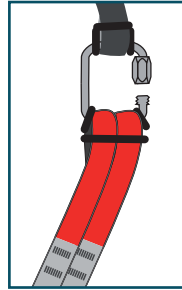

5

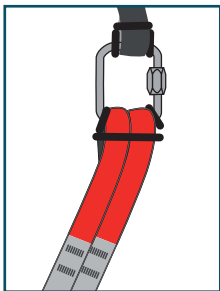

- Tidy up the assembly.
- Be certain for the riser end loops to be securely fastened.
- Close the Maillon Rapide® tightly by hand.
- Tighten using pliers and making a ¼ turn.

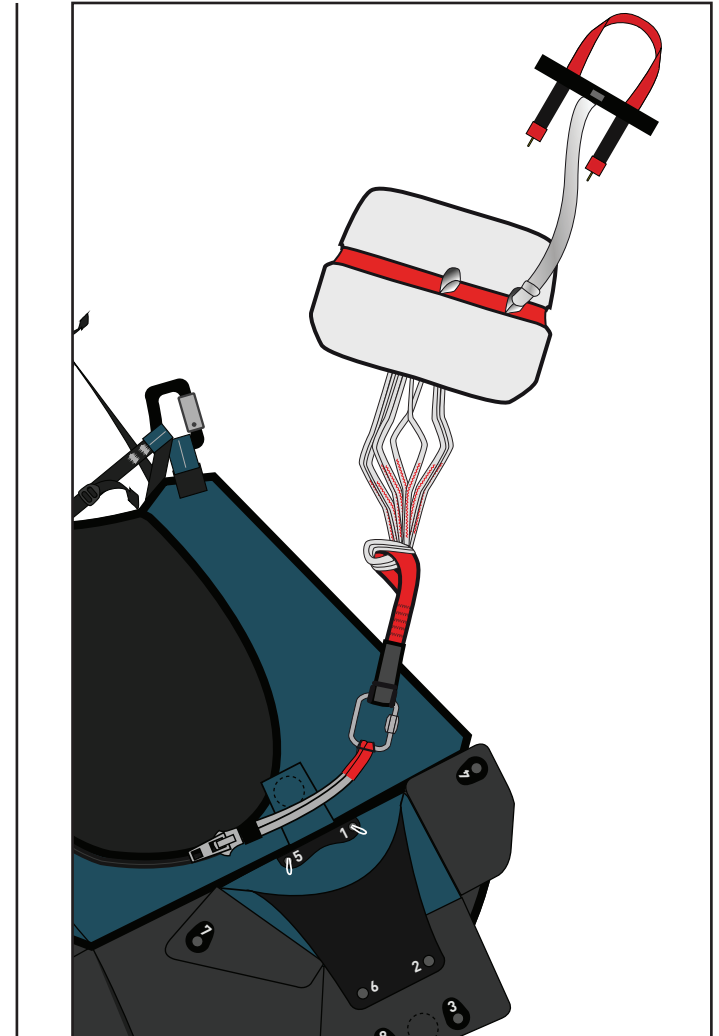

# INSTALLING THE RESERVE PARACHUTE

## Installing the reserve parachute in its container.

1

- Place the reserve parachute inside the container, with the handle positioned upward, and parachute risers downward.
- Take a small piece of line to help with the installation procedure.

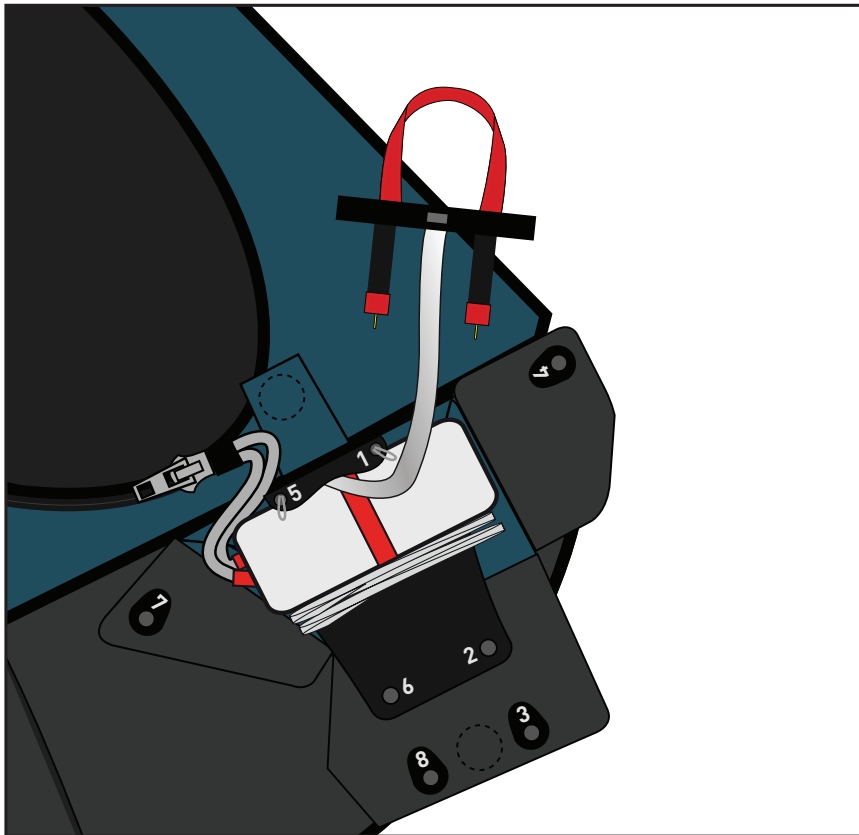

2

- Push the cord through loop «1»
- Pull loop «1» through grommet «2», «3» and «4».
- Using a second cord, pull loop «5» through grommet «6», «7» and «8».

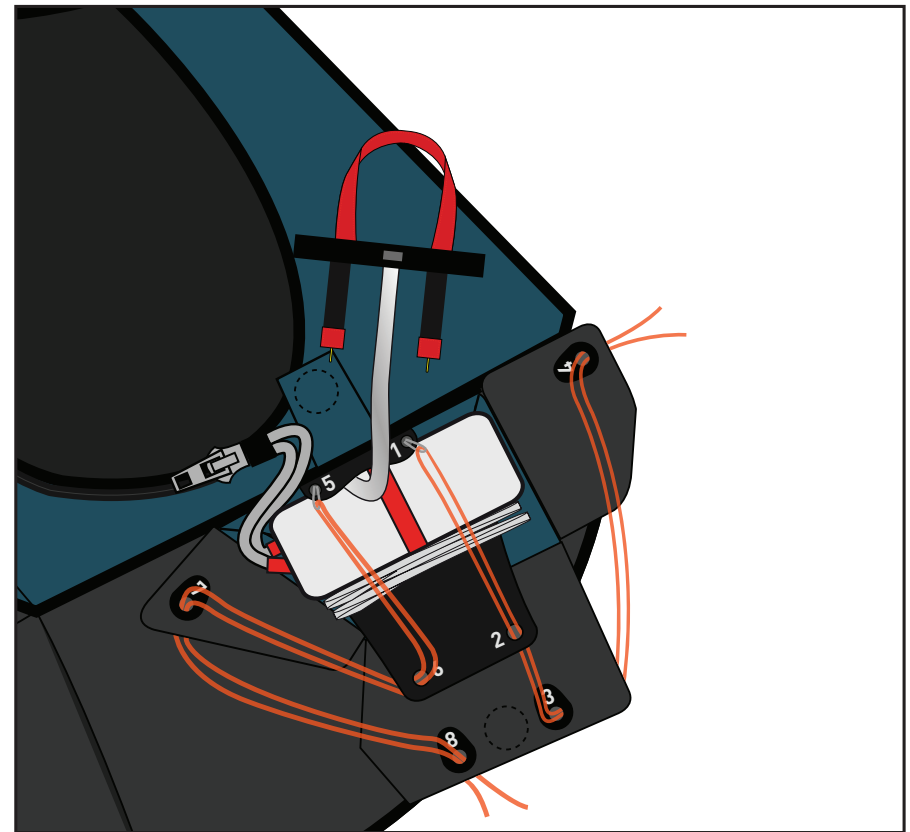

# INSTALLING THE RESERVE PARACHUTE

## Locking the reserve parachute handle.

3

- Secure the installation by pushing the right side of the yellow cable through the loop cord «1» then, the sleeve. **A**
- Secure the installation by pushing the left side of the yellow cable through the loop cord «5» then, the sleeve. **B**
- **Carefully remove the line.**
- Insert the **C** and **D** ends of the handle in their respective housing, then push the magnet flap **E** in place to secure the handle.

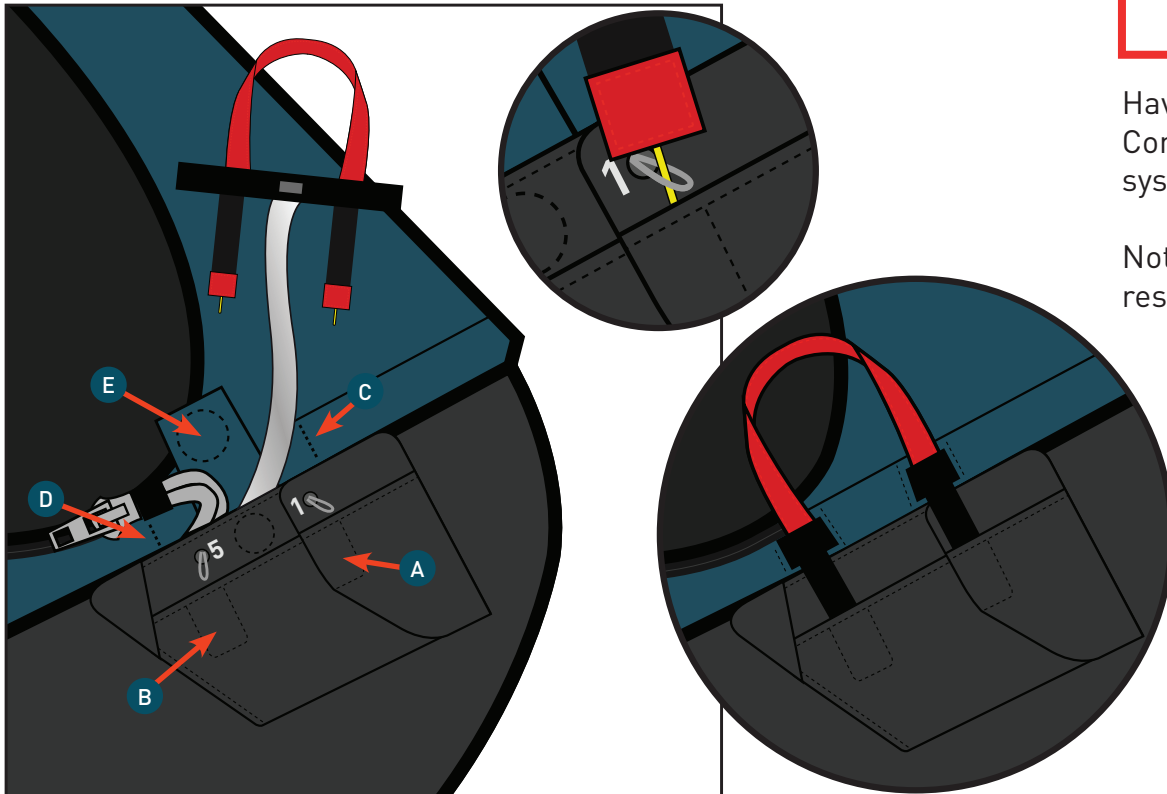

## Mandatory extraction test procedure



**Check the completed installation during a hang-test.**

Have the installation checked by a professional outfit.  
Conduct an extraction test every six ( 6 ) months to assure proper system functionality.

Note : conducting and extraction test does not imply deploying the reserve parachute which will stay inside its POD.



## GEAR PACKING AND TIPS

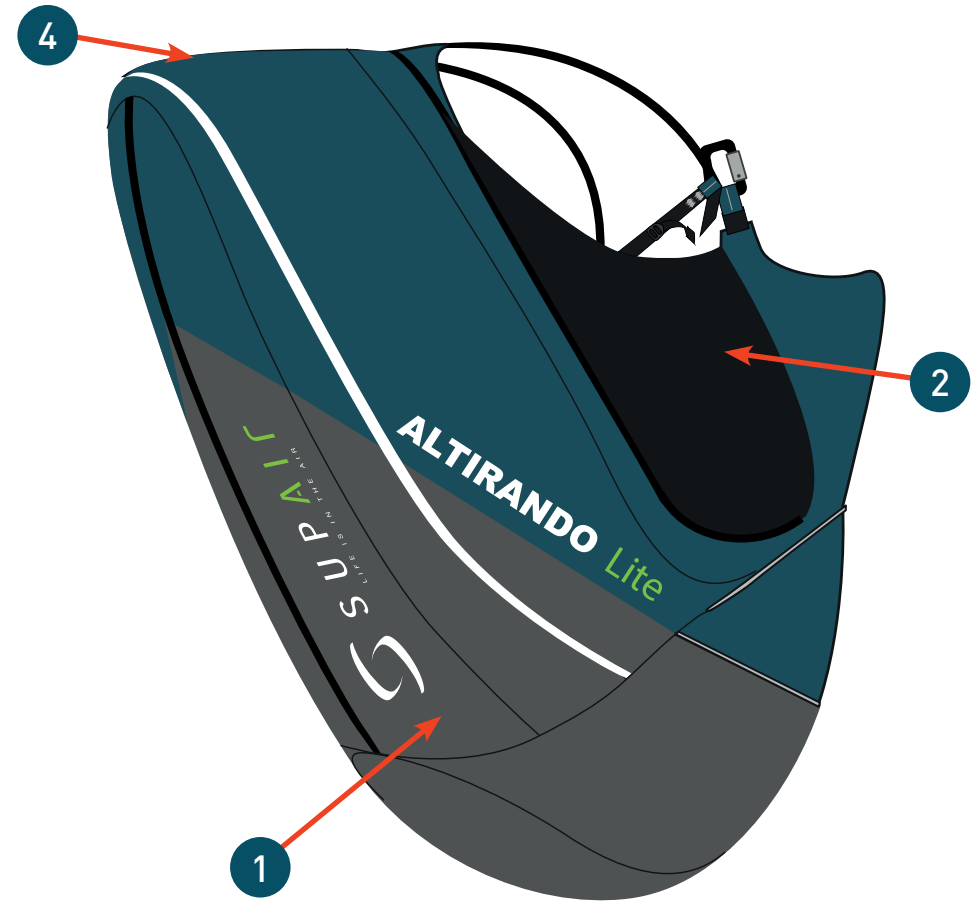
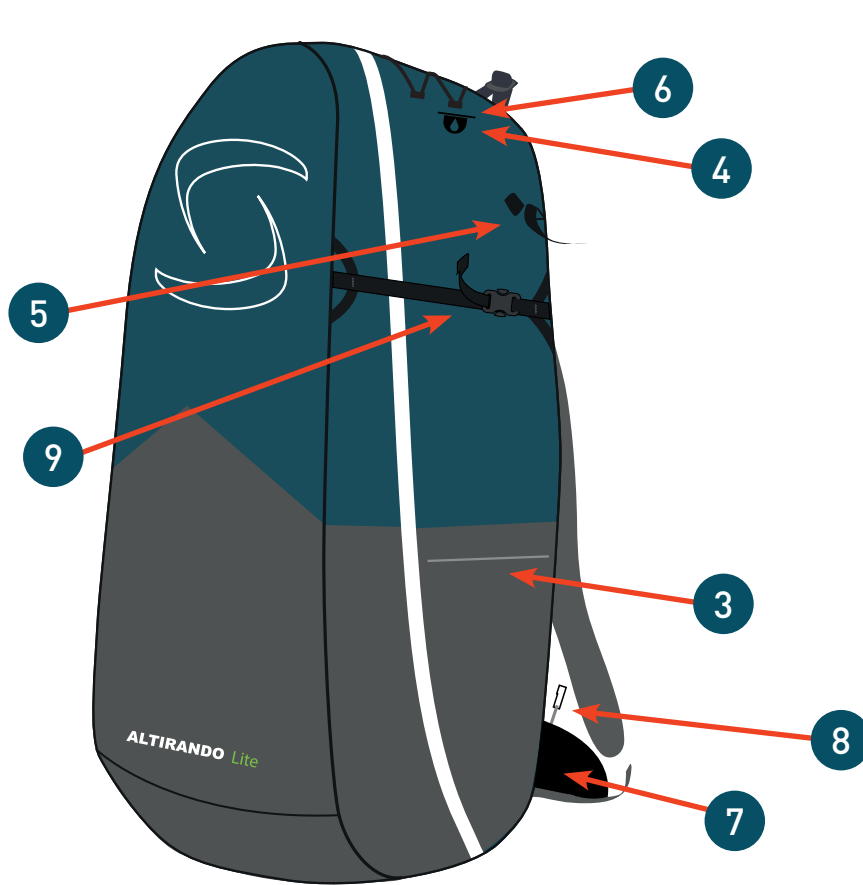

- 1 Harness configuration, large dorsal storage pocket.
- 2 Harness configuration, lateral pocket.
- 3 Backpack configuration, lateral pocket.
- 4 Hydration tube opening.
- 5 Backpack hiking poles fasteners.

- 6 Backpack compression elastic cord.
- 7 Backpack waist strap pocket.
- 8 Leash
- 9 Compression straps

# ADJUSTING THE HARNESS



Adjusting the harness prior each takeoff is vital.

## The various adjustments.

- 1 Adjusting the backrest.
- 2 Adjusting the shoulder straps.
- 3 Adjusting the chest strap.

## Adjusting the harness.

- A Sit in the harness connected to a hang-test device. Close the two interlocking rectangular buckles.
- B Adjust the shoulder straps using the shoulders adjustment buckles. 2
- C Adjust the backrest using the two lateral buckles relative to your piloting posture. 3
- D Adjusting the chest strap. The ideal distance varies between paragliding wing models. Adjust your harness's chest strap according to the wing manufacturer's recommendations. Tightening the chest-strap provides more stability but less piloting efficiency. 1



Tension on the shoulder straps helps with comfort, and must be precisely adjusted.

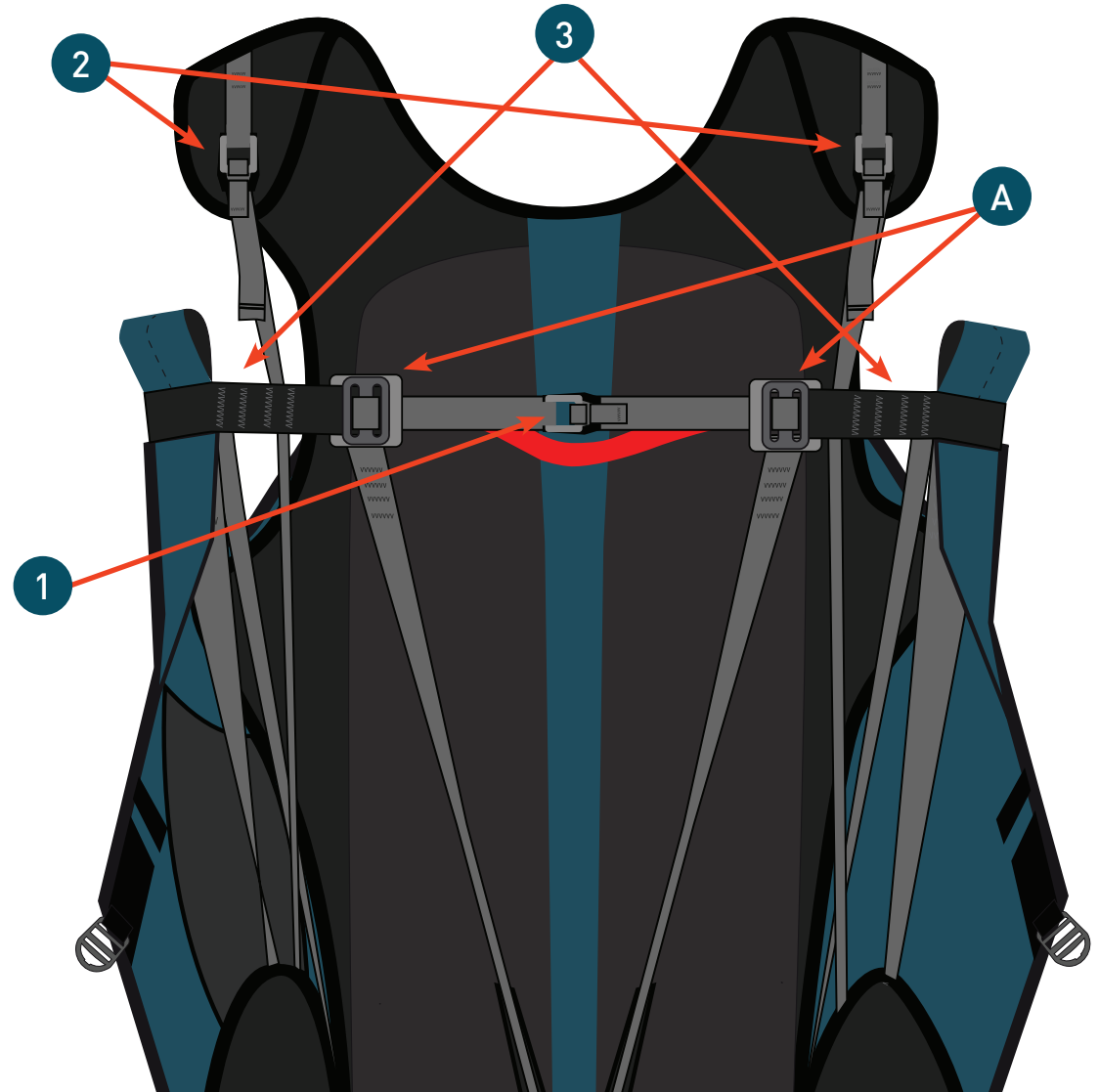
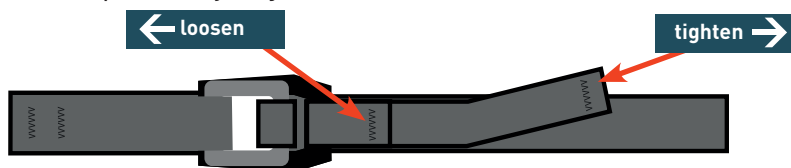

## Switching to the backpack configuration

- 1 Open the flap.
- 2 Open the zipper from end to end.
- 3 Gently deflate and compress the airbag.
- 4 Gently push the seat plate against the harness backrest.
- 5 Flip the dorsal pocket inside out.
- 6 Close the zipper and the compression strap.

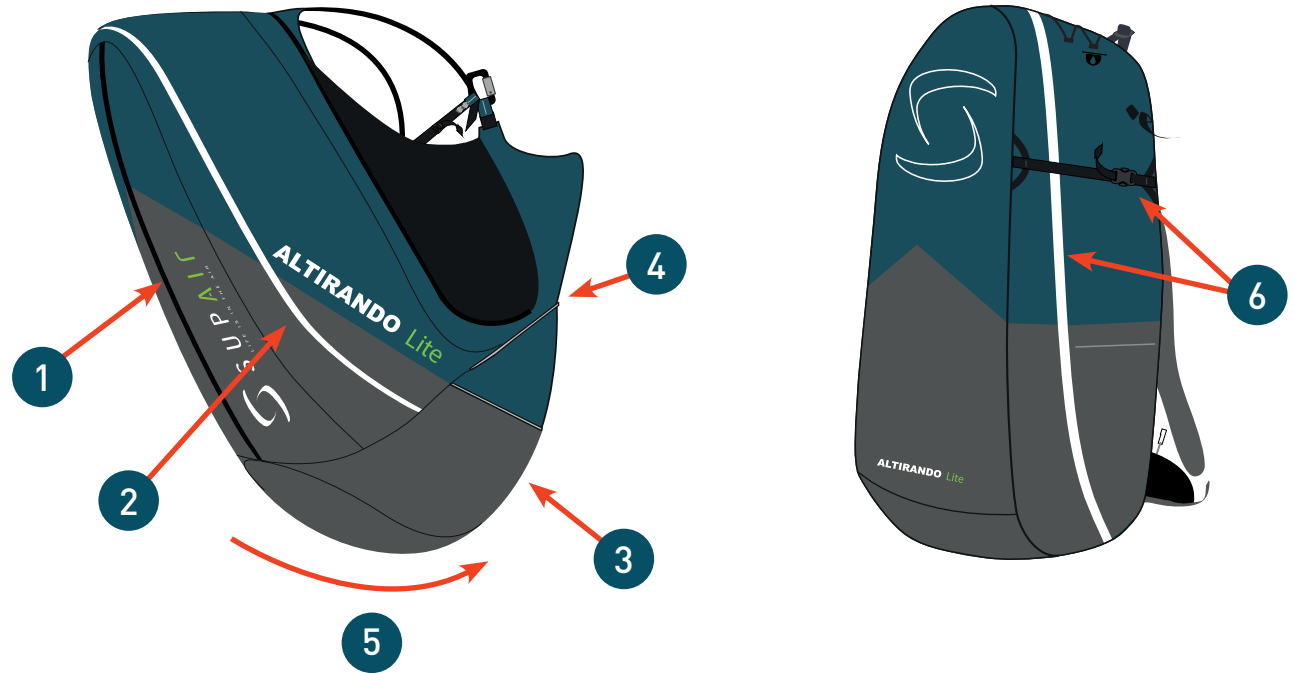

# CONNECTING THE WING TO THE HARNESS

## Connecting the wing to the harness.

Without twisting the risers, connect them to the harness attachment loops using the self-locking carabiners.

Check for the risers to be properly positioned and untwisted. The «A» risers must be located at the front and facing the flight direction (see diagram).

Enfin, vérifiez que les mousquetons soient correctement fermés.

## Installing the accelerator.

Install the accelerator by following the previous instructions. Connect it to the wing using the split hooks.

Once the accelerator/speedbar is connected adjust its length according to the wing recommended measurements.

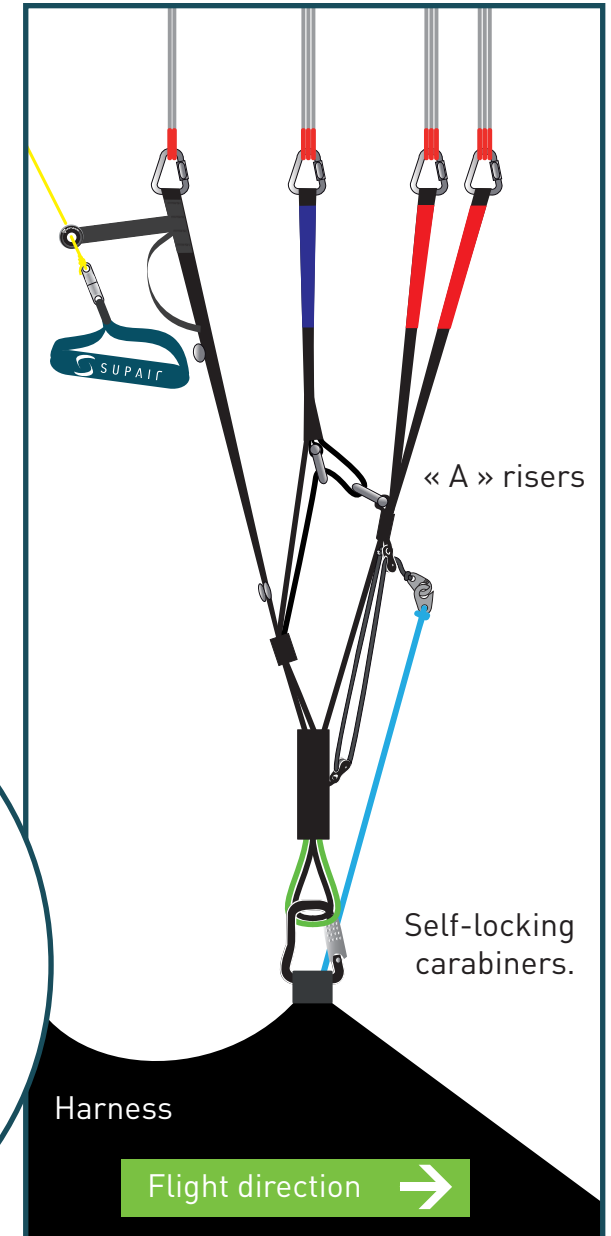
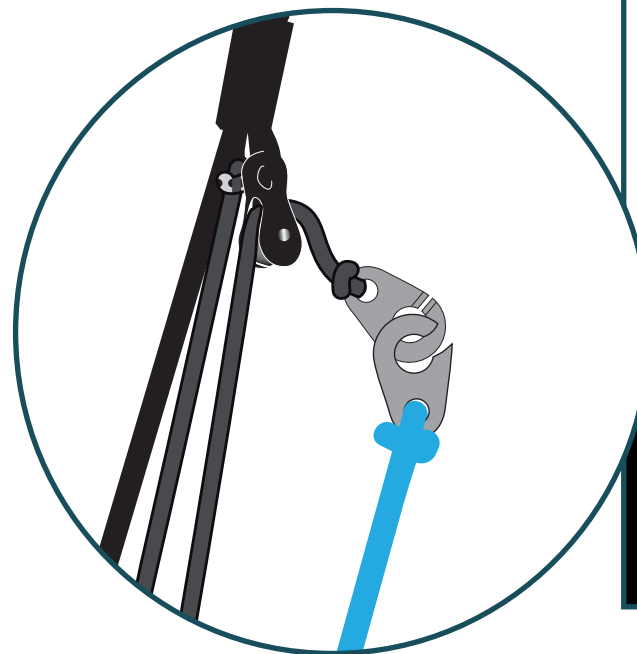

# FLIGHT BEHAVIOR



- The transition from running to seating is made easy after takeoff due to the centered geometry of the harness.
- Once airborne, weigh-shifting piloting becomes efficient, intuitive and comfortable while remaining simple to adapt to in all circumstances.
- To discover your new harness, we will recommend making your first flights on a school training hill in calm weather conditions with low wind speeds.



## Pre-Flight control



- Check that the harness and the carabiners are not damaged
- Make sure that the reserve parachute safety cables to ride through the closing tabs keeping the reserve rescue pocket flaps closed.
- Check that your personal settings haven't changed.
- Check that all zippers and buckles are closed.
- Check that the speedbar is correctly connected and set up.
- Check that no rigging line or other object comes in contact with rescue parachute handle.
- Make sure that the self-locking carabiners are locked and connected to the paraglider.

## Takeoff

After a thorough weather conditions analysis, when the decision to fly has been taken, put your harness on and follow the next steps.



- Close the two interlocking rectangular buckles.

Takeoff maintaining a vertical posture and push yourself inside the harness but only once away from the ridge.



Do not let go the brakes when close to terrain.

## In flight



Set the distance between the two carabiners according to the aerology of the moment, and the wing manufacturer's recommendations.

## Speedbar use



We recommend using the speed-bar cautiously due to the increased risk of a partial or full frontal collapses..

**Use the speed-bar/accelerator ( transitions ) only when far away from the ridge and in calm weather conditions as the wing becomes more sensitive to turbulence when accelerated. If you feel a loss of tension in the speed-bar/accelerator, stop pushing it and apply a light brake pressure on the toggles to prevent the glider from experiencing a potential frontal collapse.**



**Beware not to push on the speed-bar/accelerator to enter the harness after takeoff ( it is not a foot-rest ) or there could be the risk of a frontal collapse taking place as a result.** To use the speed-bar/accelerator, backpedal and grab the bar with the back of your shoe, push and use the second foot to stabilize it or to grab the second bar. Apply pressure symmetrically to the first stage ( first bar ), when reaching the maximum enabled distance then push on the second stage ( upper bar ). To decelerate, reverse the procedure.

## Landing



When making a landing approach, take your legs out of the Speedbag well in advance. Stand up inside the harness and adopt an upright position in order to run and dissipate the horizontal speed.

Always be certain to have enough altitude to make a landing approach corresponding to the weather conditions of the moment and terrain. During the landing approach, never make hasty maneuvers. Always land upwind in a standing posture and be ready to run upon touchdown if necessary.

During your final approach, use as much airspeed as possible based on the weather conditions of the moment, then gradually reduce the glider air speed by pushing the toggles all the way down until contact with the ground is made. Beware not to brake too soon and too rapidly and too deep which could lead to a stall and a dangerous landing.

During high wind speed landings, turnaround and face the wing as soon as ground contact is made and move toward the wing while braking symmetrically to deflate it. **Do not land in a seated position as it is dangerous.**

# USING THE RESERVE PARACHUTE

## Throwing the reserve parachute.



It is strongly recommended to frequently check your reserve parachute handle location while in flight. This exercise should be executed instinctively and will increase your chances of a successful parachute extraction in case of an emergency.

Estimate your AGL ( Altitude Above Ground Level ) which if high enough may make it worth trying to bring your wing back to a normal flying configuration. If in doubt quickly deploy your emergency parachute.

**Deploying a rescue parachute should only be done in an emergency.**



With a strong lateral and then vertical tug, pull the handle towards you and then throw the parachute away from you ( including the container and its handle ) toward a clear unobstructed area of the sky. As soon as the parachute deploys, bring as much of the glider as possible toward you by pulling symmetrically on the "C" or "D" risers or on the toggles/brakes. Be prepared to land by adopting an upright position with knees together and legs slightly bent. Prepare to roll down, hands on your chest, ankles together with pivoting hips and shoulders in a Paragliding Landing Fall (PLF) configuration.

## TOWING

To takeoff under tow you must be equipped with a quick release specially designed for the task. Connect the towing release system to the main carabiner attachment points in accordance to manufacturer recommendations. Before towing you should consult with a competent towing outfit about safety recommendations.

## MANDATORY CONTROLS

### Mandatory biannual inspection :



- Ascertain parachute deployment functionality by pulling the handle to activate a clean POD extraction sequence.
- Inspect the harness for wear and tear.

### Annual check :



An annual deployment and repacking of the reserve parachute must be conducted by competent and certified personnel.

## Call for help after an accident.

### Emergency call numbers



EUROPE / INDIA	112
USA / CANADA	911
CHINA / JAPAN	119
NEPAL	101
IRAN	112
AUSTRALIA	000
NEW ZEALAND	111

### Help needed?

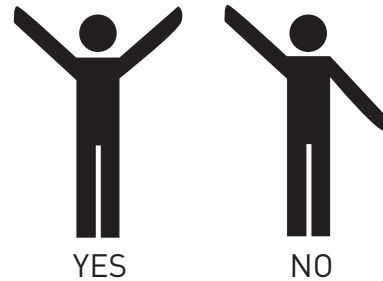

### Flashlight SOS:



## Harness cleaning and maintenance.

It is a good idea to clean your harness from time to time. We recommend using a brush and soft solvents only ( soap or mild cleaning agents ). Rinse thoroughly. Never use aggressive chemicals such as strong solvents which could be harmful to the fabric, webbings, stitching and weaken the overall integrity of the harness.

The zippers should be lubricated from time to time using a silicon spray.

If you regularly use your harness in a dusty environment ( dirt sand etc... ) we advise you to regularly check and maintain your carabiners and buckles : clean them with a mild detergent then blow-dry them fully but **DO NOT LUBRICATE !**

Prior to using them conduct a thorough carabiners and buckles checkup to insure their full functionality.

If you use your harness in a marine/sandy/salty environment pay particular attention to your gear and follow a regular rigorous maintenance routine. If an air-bag protection is used instead, check for damage. The harness will need to be inspected at a professional certified repair facility.

## Storage and transport

When not in use, your harness should be stored inside your paragliding backpack, in a dry, cool and clean place, protected from UV exposure. If your harness is wet, please dry it thoroughly before storing. For transport, protect the harness from any mechanical or UV deterioration (use a bag). Please avoid long transports in wet conditions.

## Life span



Once every two (2) years a thorough harness inspection must be conducted :

- Webbing wear and tear (no excessive wear nor rip beginning or unwanted folds).
- Buckles and carabiners ( functionality wear and tear ).
- The AIRBAG's integrity ( especially after a strong impact ), in other words, no holes, tears or rips.



The threads and fabric used to manufacture the ALTIRANDO LITE were specifically selected for their quality and resilience capacities. However in particular instances such as long term UV exposure abrasion, contact with damaging chemicals, general wear and tear, the harness will need to be inspected at a professional certified repair facility. Safety comes first!



The self-locking carabiners are NEVER to be used for any activities other than paragliding.

Independently of the pre-flight check-out, you have to open and unfold your rescue parachute once every year.

## Repairs

In spite of using the highest quality products used for manufacturing, it is possible for your harness to deteriorate through general use. If showing any sign of wear and tear it should be sent for inspection and/or repairs at a professional certified facility.



SUPAIR now offers an extended warranty period reaching beyond the product standard protection plan against manufacturing defects. Please contact us either by telephone or by E-mail [sav@supair.com](mailto:sav@supair.com) in order to receive a quotation.

## Hardware & Parts

- Self-locking Zicral 30mm carabiners. (ref : MAILCOMOUS 30)
- Polypropylene seat plate ( ref : S : MPPL030 | M : MPPL031 | L : MPPL032 | XL : MPPL033)
- Reserve parachute handle ( ref : POIATL)
- Accelerator/speedbar Split-hooks (ref : MPPM050)

## Materials

### Fabrics

Nylon Honey Comb 210D  
Nylon ripstop 210D

### Straps

Polyamide 20 mm (500 daN)  
Polyamide 15 mm (800 daN)

## Recycling

We have minimized our manufacturing footprint by carefully selecting environmentally friendly materials; most of our components are recyclable.

If you estimate that your ALTIRANDO LITE has reached the end of its life-span, you can separate plastics from metals and dispose of them according to your community recycling rules. As for the fabric itself contact your local authorities to find out how to proceed to discard it.



## WARRANTY

SUP'AIR takes the greatest care in its products design and manufacturing and hence offers a five (5) year limited warranty from the date of purchase against manufacturing defects or flaws occurring during normal use. Any damage or degradation resulting from incorrect or abusive use, abnormal exposure to aggressive factors, including, but not limited to; high temperature, intense sun exposure, high humidity etc, will invalidate this warranty.

The provided safety protections in the SUPAIR harnesses are guaranteed for use in medium temperature (between -10°C and 35°C).The protections lifespan is 5 years or limited to 2 consequent shocks. If an airbag is used instead of foam, check that it is correctly installed.

## DISCLAIMER



Paragliding is an activity requiring specific skills and sound judgement. Learn how to fly within the environment of a certified paragliding school. Carry an insurance policy with you in addition to you pilot certification. Always mind and gauge your personal skills relative to the elements you want to be flying in. Better be safe than sorry ! SUP'AIR can not be held responsible for your paragliding decisions or activities.



This SUP'AIR product has been designed exclusively for paragliding. Any other activity such as skydiving or BASE jumping is absolutely forbidden.



It is essential for you to wear a suitable head protection ( certified paragliding helmet ), boots and right clothing for the activity. Moreover, carrying a reserve parachute connected to your harness in flight is highly recommend.

## PILOT'S GEAR

## CE CERTIFICATION : ABOUT THE PARAGLIDING HARNESSES PROTECTION

We want to inform you and let you know that no harness protection can guarantee a complete protection against injury. In particular,the back protector which does not prevent potential injuries to the spine or pelvis.Moreover, only parts of the body covered by the air bag or Bumpair may benefit from protection against potential impacts.



Warning, any modification or misuse of the protection can dangerously alter its performance and compromise the integrity of the safety device.

Protection is ensured only when the protective elements are present and properly installed. Thus, when the protection is removable,check that it is correctly positioned.

Your harness protection CE conformity labeling is certified by the following laboratory :

CRITT Sport Loisirs n°0501 ,Z.A. du Sanital, 21 Rue Albert Einstein, 86100 Châtellerault, FRANCE

This page will help you keep record of your ALTIRANDO LITE scheduled maintenance.

Purchase date	
Owner's name :	
Name and stamp of the shop :	

<input type="checkbox"/> Care	
<input type="checkbox"/> Resale	
Date	
Workshop's name/ Buyer's name	

<input type="checkbox"/> Care	
<input type="checkbox"/> Resale	
Date	
Workshop's name/ Buyer's name	

<input type="checkbox"/> Care	
<input type="checkbox"/> Resale	
Date	
Workshop's name/ Buyer's name	

<input type="checkbox"/> Care	
<input type="checkbox"/> Resale	
Date	
Workshop's name/ Buyer's name	



SUPAIR-VLD  
Parc Altaïs  
34 rue Adrastée  
74650 Chavanod, Annecy  
FRANCE

[info@supair.com](mailto:info@supair.com)  
+33(0)4 50 45 75 29

45°54.024'N / 06°04.725'E